

1851

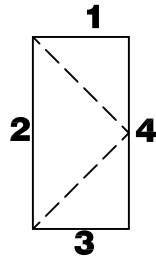

1855

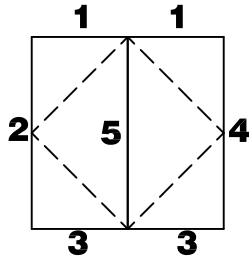

1852

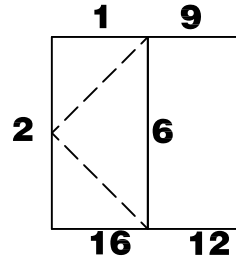

1853

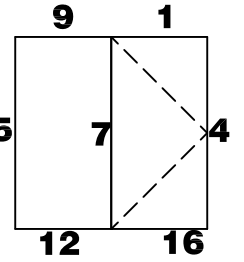

1854

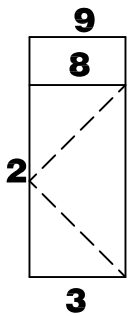

1857

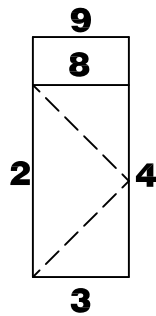

1858

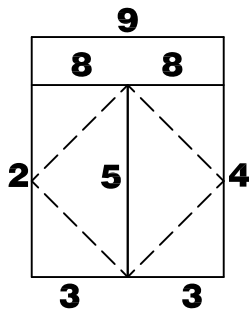

1859

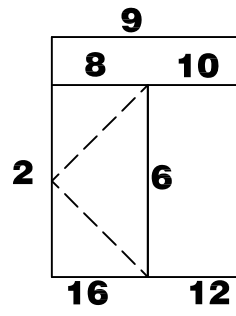

1896

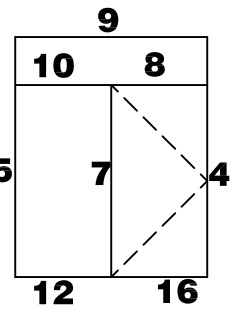

189A

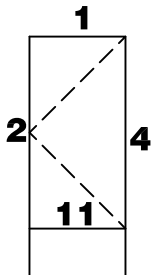

180E

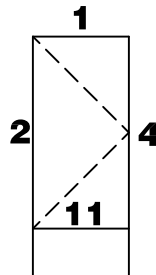

180D

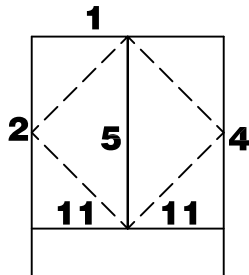

185A

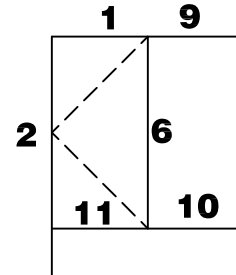

180B

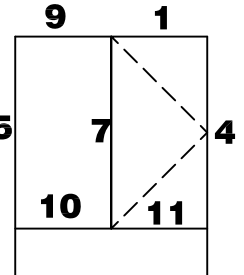

180A

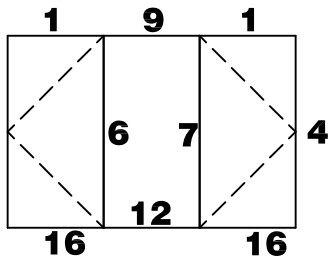

1856

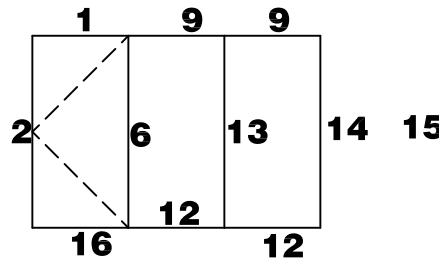

185B

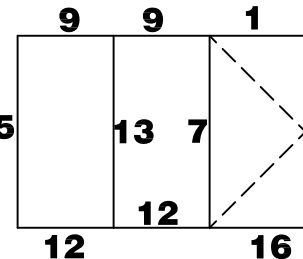

185C

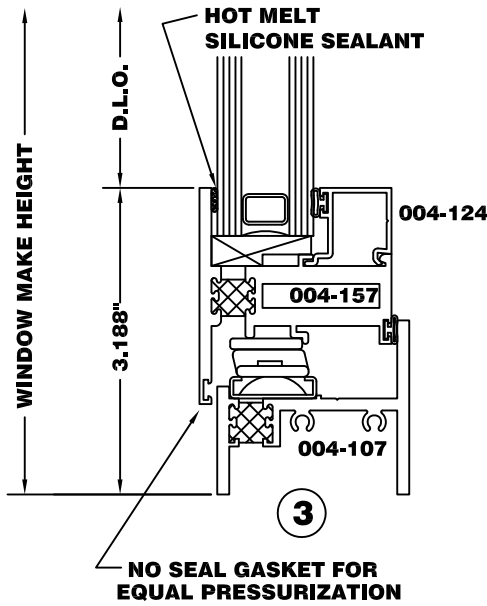
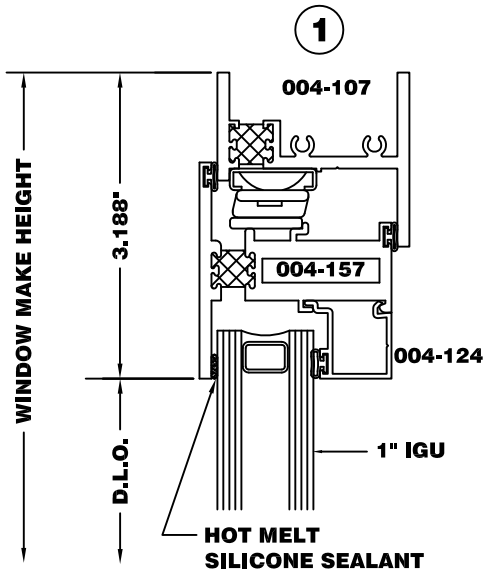

NO SEAL GASKET FOR
EQUAL PRESSURIZATION

