

1961

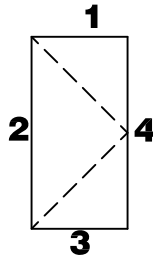

1965

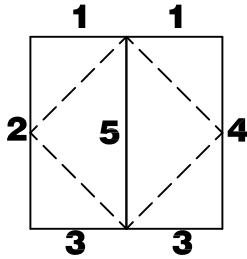

1962

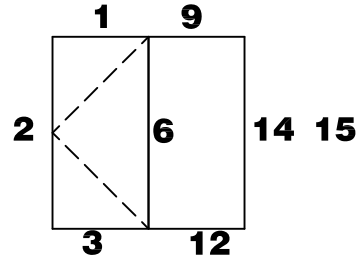

1963

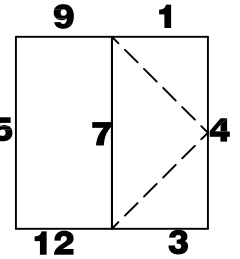

1964

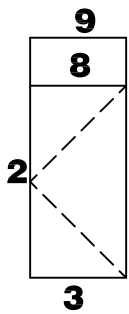

1967

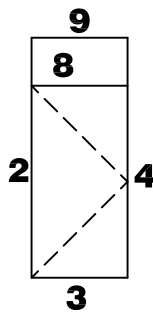

1968

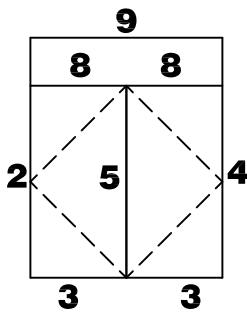

1969

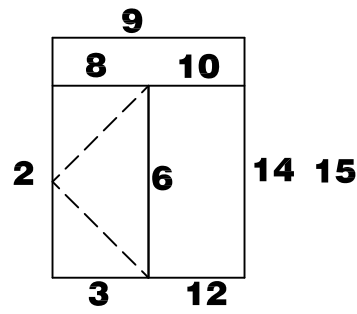

199C

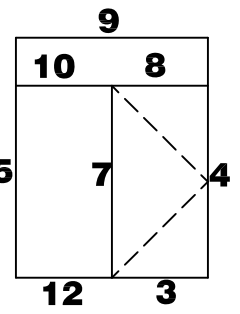

199D

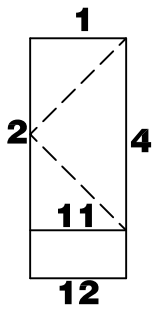

190I

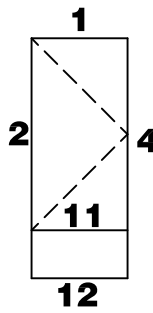

190J

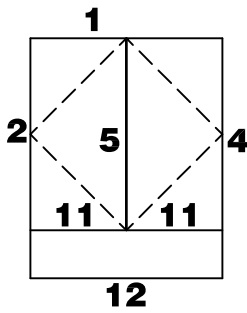

196A

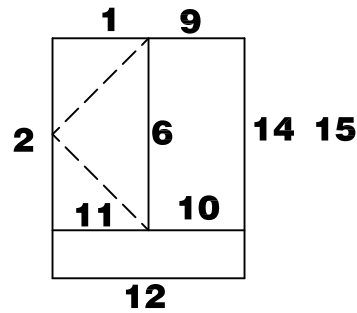

190K

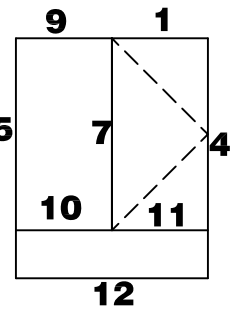

190L

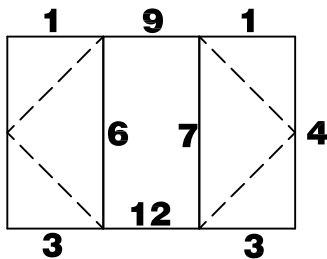

1966

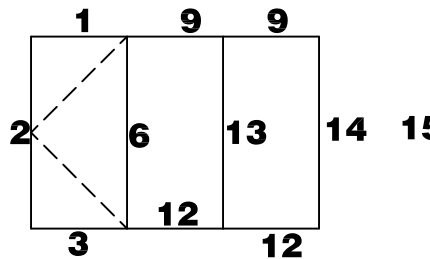

196B

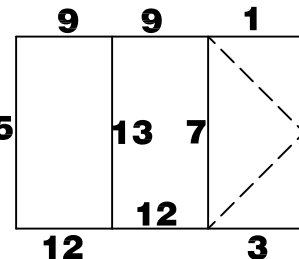

196C

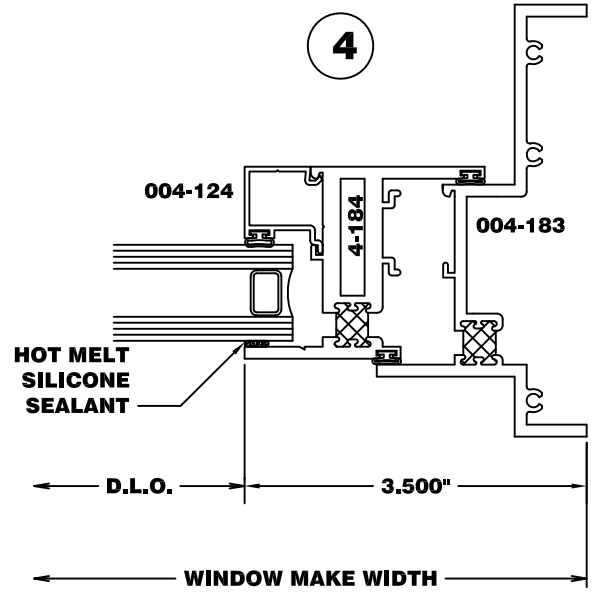
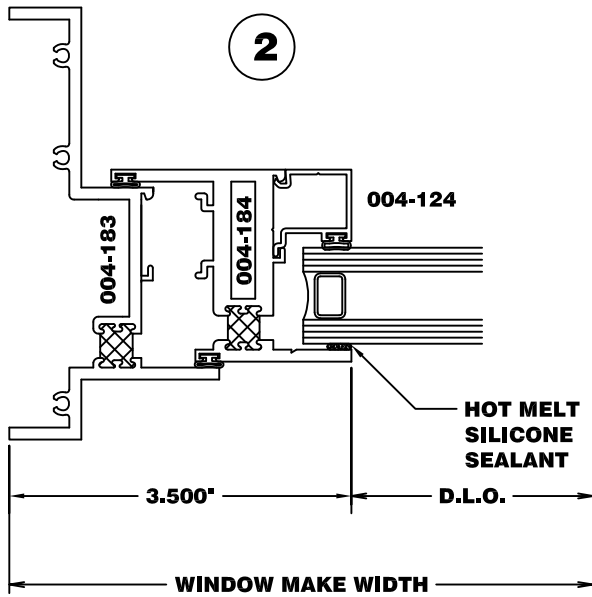
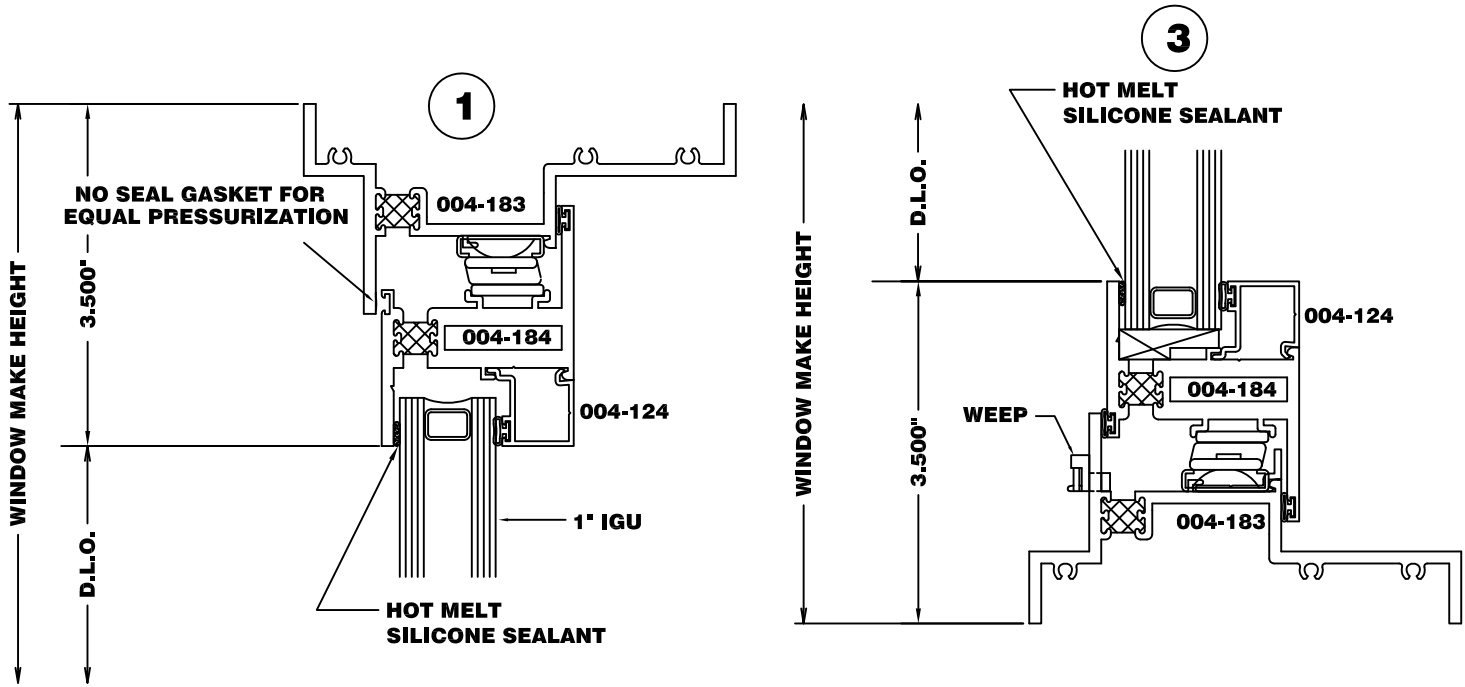

5

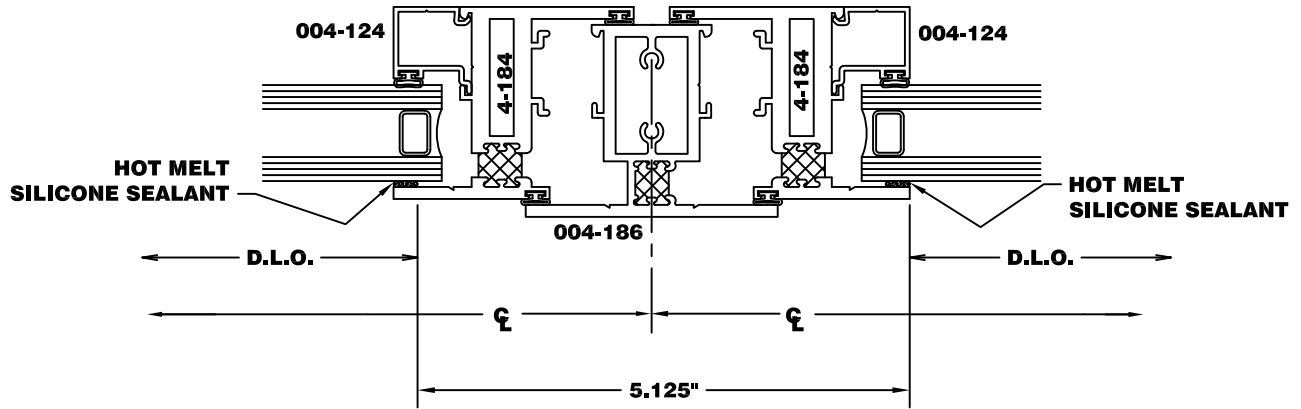

6

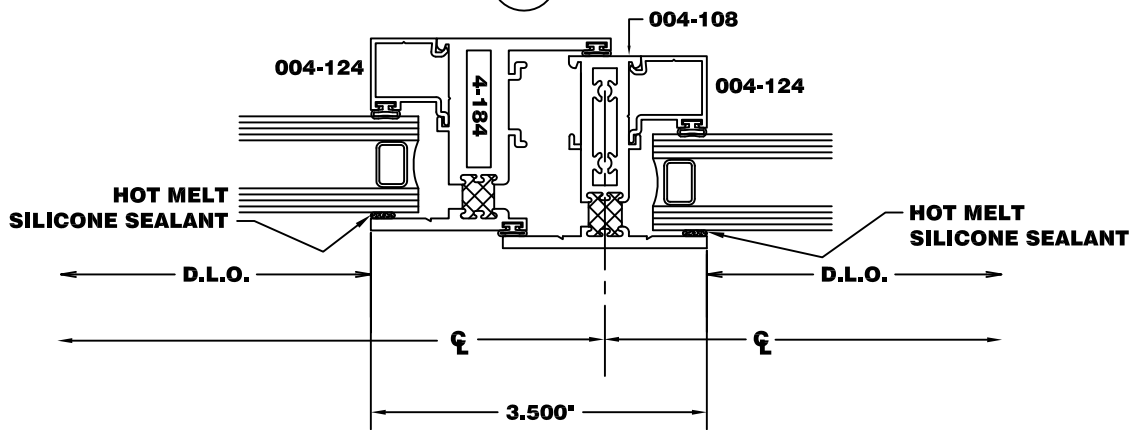

7

