

2501

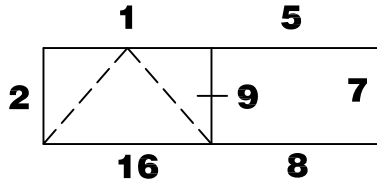

2509

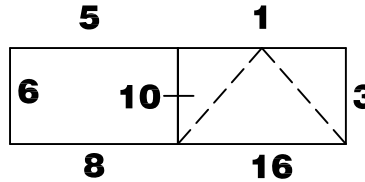

2508

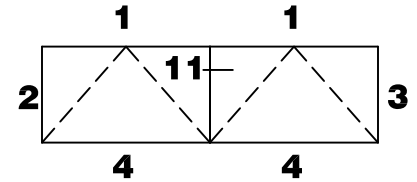

2504

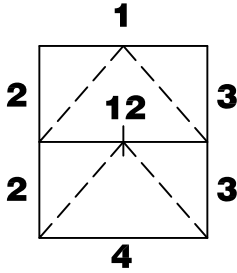

2502

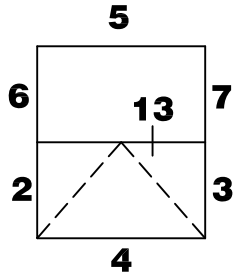

2505

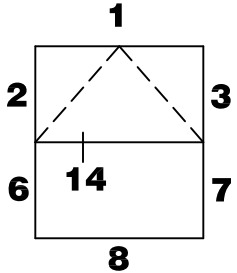

2506

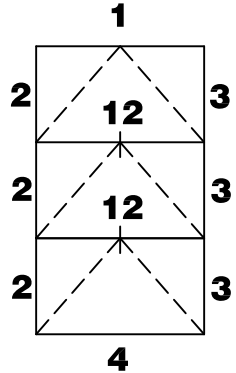

2503

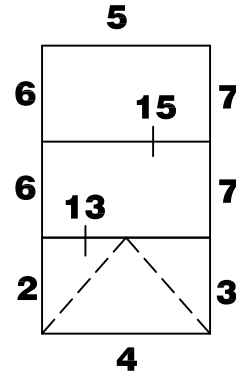

2507

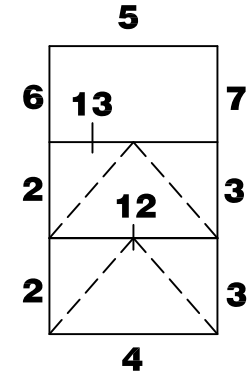

2576

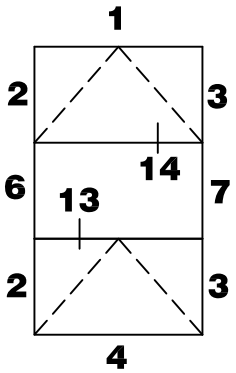

2578

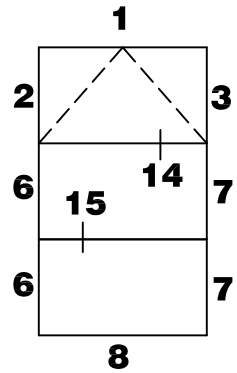

2584

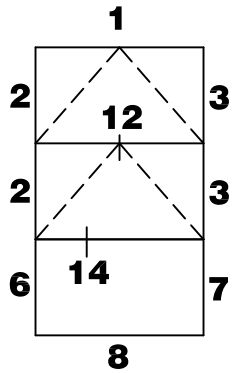

2577

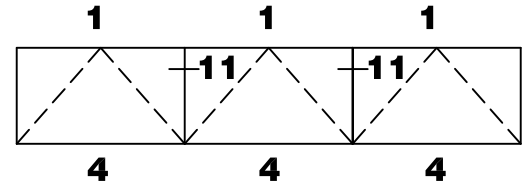

2583

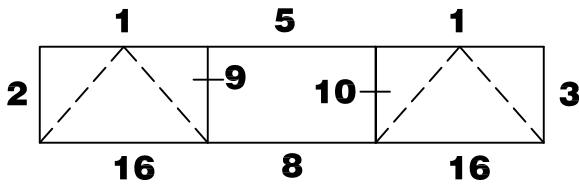

2573

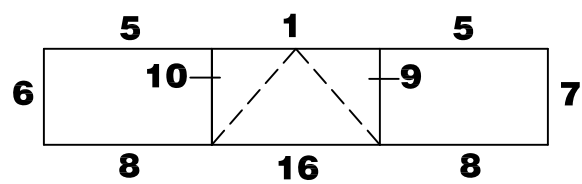

2534

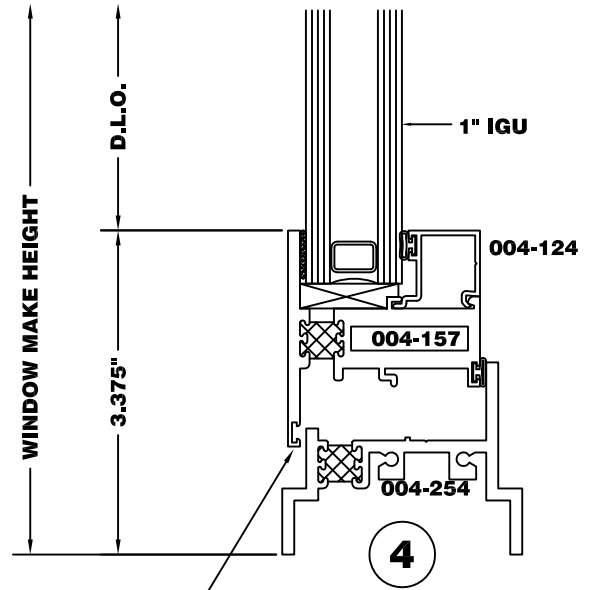
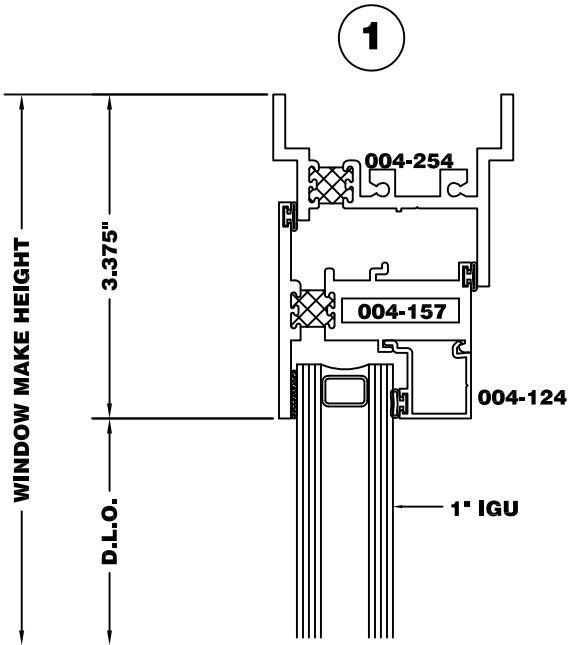

NO SEAL GASKET FOR
 EQUAL PRESSURIZATION

